

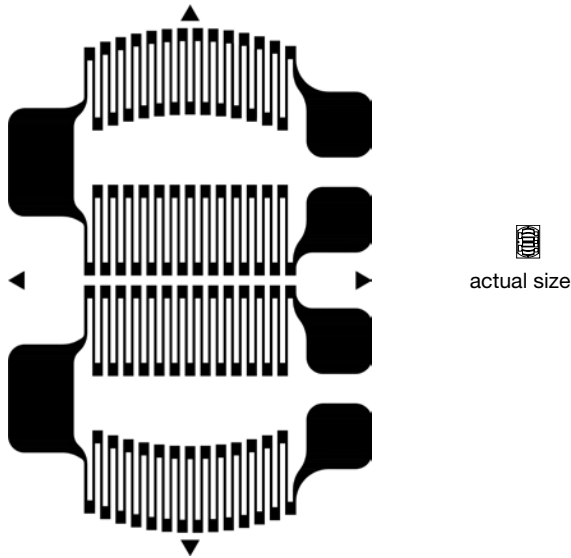



Transducer-Class® Strain Gages with Advanced Sensors Technology

S5206 GAGE PATTERN DATA			
	GAGE DESIGNATION	RESISTANCE IN OHMS	STD. CREEP CODE
	N2K-XX-S5206F-50C/DG/E5 N5K-XX-S5206F-50C/DG/E5	5000 ±0.3% 5000 ±0.3%	F* F*
DESCRIPTION Full-bridge pattern for use on 0.174 in (4.42 mm) diameter diaphragm.			 RoHS COMPLIANT

GAGE DIMENSIONS					
		inch		millimeter	
Gage Length	Overall Length	Grid Width	Overall Width	Matrix Length	Matrix Width
0.019	0.146	0.065	0.111	0.17	0.12
0.48	3.70	1.65	2.82	4.4	3.0

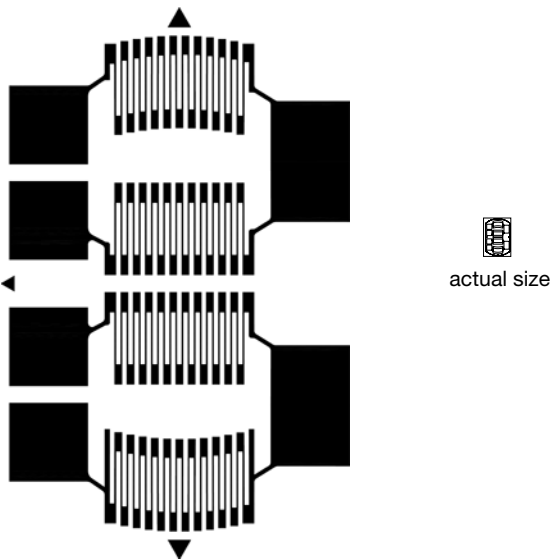

* Only creep code available for this gage.
Copper plating for tabs is available.

GAGE PATTERN DATA			
	GAGE DESIGNATION	RESISTANCE IN OHMS	STD. CREEP CODE
	N2K-XX-S5065M-350/DG/E5 N5K-XX-S5065M-350/DG/E5 N2K-XX-S5021M-50C/DG/E5 N5K-XX-S5021M-50C/DG/E5	350 ±0.3% 350 ±0.3% 5000 ±0.3% 5000 ±0.3%	M* M* M* M*
DESCRIPTION Full-bridge pattern for use on 0.200 in (5.080 mm) diameter diaphragm.			 RoHS COMPLIANT

GAGE DIMENSIONS					
		inch		millimeter	
Gage Length	Overall Length	Grid Width	Overall Width	Matrix Length	Matrix Width
0.019	0.168	0.059	0.117	0.20	0.13
0.49	4.27	1.50	2.96	5.1	3.2

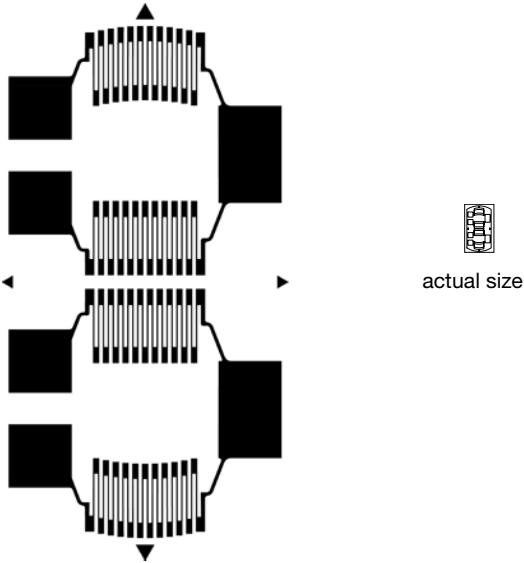

* Only creep code available for this gage.
Copper plating for tabs is available.

Transducer-Class® Strain Gages with Advanced Sensors Technology

GAGE PATTERN DATA			
	GAGE DESIGNATION	RESISTANCE IN OHMS	STD. CREEP CODE
	N2K-XX-S5066M-350/DG/E5 N5K-XX-S5066M-350/DG/E5 N2K-XX-S5022M-50C/DG/E5 N5K-XX-S5022M-50C/DG/E5	350 ±0.3% 350 ±0.3% 5000 ±0.3% 5000 ±0.3%	M* M* M* M*
DESCRIPTION Full-bridge pattern for use on 0.250 in (6.35 mm) diameter diaphragm.			 RoHS COMPLIANT

GAGE DIMENSIONS					
				inch	millimeter
Gage Length	Overall Length	Grid Width	Overall Width	Matrix Length	Matrix Width
0.020	0.212	0.050	0.112	0.25	0.12
0.51	5.38	1.27	2.84	6.4	3.1

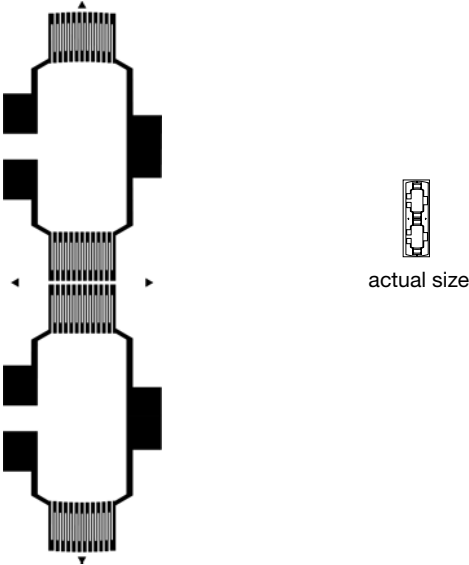

* Only creep code available for this gage.
Copper plating for tabs is available.

S5026 GAGE PATTERN DATA			
	GAGE DESIGNATION	RESISTANCE IN OHMS	STD. CREEP CODE
	N2K-XX-S5026M-50C/DG/E5 N5K-XX-S5026M-50C/DG/E5	5000 ±0.3% 5000 ±0.3%	M* M*
DESCRIPTION Full bridge pattern for use on 0.400 in (10.16 mm) diameter diaphragm.			 RoHS COMPLIANT

GAGE DIMENSIONS					
				inch	millimeter
Gage Length	Overall Length	Grid Width	Overall Width	Matrix Length	Matrix Width
0.020	0.368	0.044	0.111	0.40	0.12
0.51	9.35	1.12	2.82	10.2	3.1

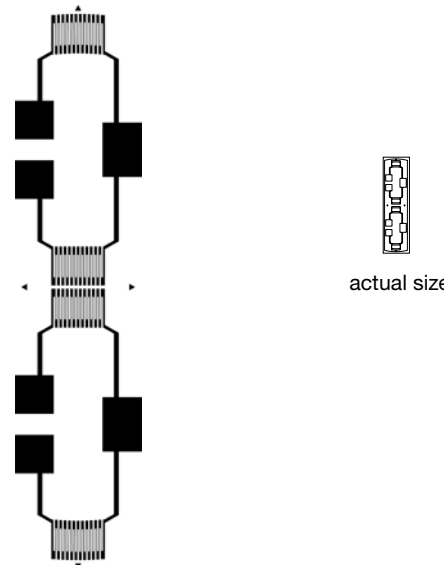

* Only creep code available for this gage.
Copper plating for tabs is available.

Transducer-Class® Strain Gages with Advanced Sensors Technology

S5025 GAGE PATTERN DATA			
 <p>actual size</p>	GAGE DESIGNATION	RESISTANCE IN OHMS	STD. CREEP CODE
	N2K-XX-S5025M-50C/DG/E5 N5K-XX-S5025M-50C/DG/E5	5000 ±0.3% 5000 ±0.3%	M* M*
DESCRIPTION Full-bridge pattern for use on 0.500 in (12.7 mm) diameter diaphragm.			

GAGE DIMENSIONS					
				inch	millimeter
Gage Length	Overall Length	Grid Width	Overall Width	Matrix Length	Matrix Width
0.020	0.483	0.047	0.111	0.50	0.12
0.51	12.26	1.19	2.82	12.7	3.1

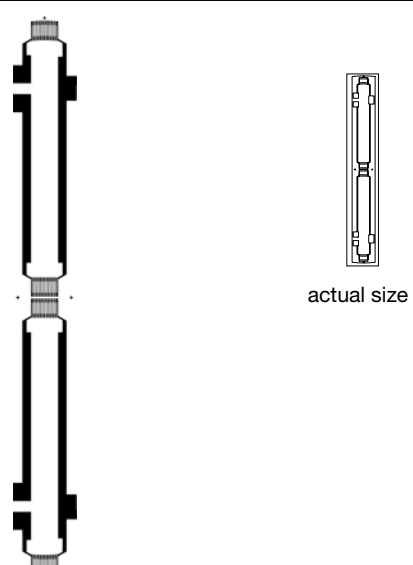

* Only creep code available for this gage.
Copper plating for tabs is available.

S5071 GAGE PATTERN DATA			
 <p>actual size</p>	GAGE DESIGNATION	RESISTANCE IN OHMS	STD. CREEP CODE
	N2K-XX-S5071M-50C/DG/E5 N5K-XX-S5071M-50C/DG/E5	5000 ±0.3% 5000 ±0.3%	M* M*
DESCRIPTION Full-bridge pattern for use on 1.00 in (25.4 mm) diameter diaphragm.			

GAGE DIMENSIONS					
				inch	millimeter
Gage Length	Overall Length	Grid Width	Overall Width	Matrix Length	Matrix Width
0.020	0.968	0.047	0.111	1.00	0.12
0.51	24.59	1.19	2.82	25.4	3.1

* Only creep code available for this gage.
Copper plating for tabs is available.

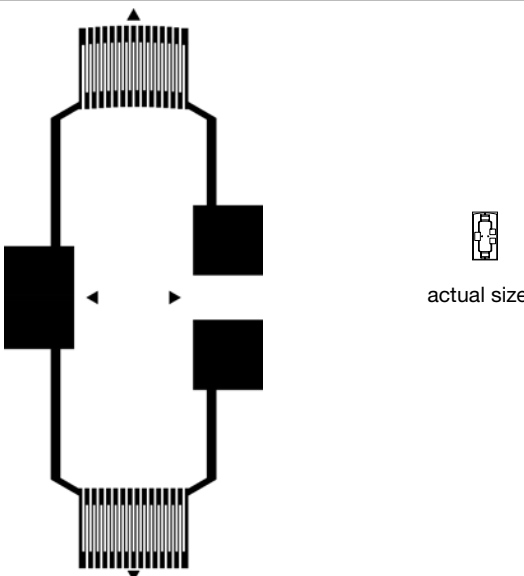
Transducer-Class® Strain Gages with Advanced Sensors Technology

S5050 GAGE PATTERN DATA			
 <p>actual size</p>	GAGE DESIGNATION	RESISTANCE IN OHMS	STD. CREEP CODE
	N2K-XX-S5050M-30C/DG/E5 N5K-XX-S5050M-30C/DG/E5	3000 ±0.3% 3000 ±0.3%	M* M*
DESCRIPTION Half-bridge diaphragm configuration.			

GAGE DIMENSIONS					
				inch	millimeter
Gage Length	Overall Length	Grid Width	Overall Width	Matrix Length	Matrix Width
0.020	0.217	0.047	0.111	0.25	0.13
0.51	5.52	1.19	2.82	6.4	3.2

* Only creep code available for this gage.
Copper plating for tabs is available.



Disclaimer

ALL PRODUCTS, PRODUCT SPECIFICATIONS AND DATA ARE SUBJECT TO CHANGE WITHOUT NOTICE.

Vishay Precision Group, Inc., its affiliates, agents, and employees, and all persons acting on its or their behalf (collectively, "VPG"), disclaim any and all liability for any errors, inaccuracies or incompleteness contained herein or in any other disclosure relating to any product.

The product specifications do not expand or otherwise modify VPG's terms and conditions of purchase, including but not limited to, the warranty expressed therein.

VPG makes no warranty, representation or guarantee other than as set forth in the terms and conditions of purchase. **To the maximum extent permitted by applicable law, VPG disclaims (i) any and all liability arising out of the application or use of any product, (ii) any and all liability, including without limitation special, consequential or incidental damages, and (iii) any and all implied warranties, including warranties of fitness for particular purpose, non-infringement and merchantability.**

Information provided in datasheets and/or specifications may vary from actual results in different applications and performance may vary over time. Statements regarding the suitability of products for certain types of applications are based on VPG's knowledge of typical requirements that are often placed on VPG products. It is the customer's responsibility to validate that a particular product with the properties described in the product specification is suitable for use in a particular application. You should ensure you have the current version of the relevant information by contacting VPG prior to performing installation or use of the product, such as on our website at vpgsensors.com.

No license, express, implied, or otherwise, to any intellectual property rights is granted by this document, or by any conduct of VPG.

The products shown herein are not designed for use in life-saving or life-sustaining applications unless otherwise expressly indicated. Customers using or selling VPG products not expressly indicated for use in such applications do so entirely at their own risk and agree to fully indemnify VPG for any damages arising or resulting from such use or sale. Please contact authorized VPG personnel to obtain written terms and conditions regarding products designed for such applications.

Product names and markings noted herein may be trademarks of their respective owners.

Copyright Vishay Precision Group, Inc., 2014. All rights reserved.